

TC73 and TC78 Accessories Guide

The ultra-rugged mobile computer re-imagined for the new age of mobility

Revised November 2022



I.	Accessories that POWER devices	
	1 Cradles	
1.1	Single-slot chargers	3
1.2	Multi-slot chargers	4
1.3	Mounting options for chargers	5
	2 Batteries	
2.1	Spare Li-ion batteries with BLE Beacon	5
2.2	Spare Li-ion batteries	5
2.3	Spare battery chargers	6
	3 Power supply, cables, and adapters	
3.1	Power supply and cable matrix	7
3.2	Country-specific AC line cords	8
	4 Vehicle chargers and accessories	10
II.	Accessories that ENABLE productivity solutions	
	5 Vehicle holders and mounts	11
	6 Headsets	
6.1	Wired headsets and accessories for Workforce Connect	12
6.2	Wired headsets and accessories for voice-directed picking	13
6.3	Wireless headsets and accessories for voice-directed picking	13
	7 Wearable mounts and other accessories	
7.1	Wrist mount and straps	14
7.2	Hand straps, carrying (belt) clip, and stylus	16
	8 Trigger handles	
8.1	Electronic trigger handle	17
	9 Cables and adaptors	18
III.	Accessories that PROTECT devices	
	10 Soft holsters and screen protectors	19

Cradles



Single-slot charger

SKU# CRD-NGTC7-2SC1B

Single-slot charge-only ShareCradle kit. Charges a single device and any TC73 / TC78 spare Li-ion battery.

- Device with standard battery charges from 0–80% in about 1½ hours.
- Includes: Power supply SKU# PWR-BGA12V50W0WW and DC cable SKU# CBL-DC-388A1-01.
- Sold separately: Country-specific AC line cord (listed later in this document).



Single-slot USB/Ethernet capable charger

SKU# CRD-NGTC7-2SE1B

Single-slot charge and USB ShareCradle kit. Charges a single device and any TC73 / TC78 spare Li-ion battery.

- Device with standard battery charges from 0–80% in about 1½ hours.
- Includes: Power supply SKU# PWR-BGA12V50W0WW and DC cable SKU# CBL-DC-388A1-01.
- Sold separately: Country-specific AC line cord (listed later in this document), micro-USB cable SKU# 25-124330-01R, and USB to Ethernet module kit SKU# MOD-MT2-EU1-01



USB to Ethernet module kit

SKU# MOD-MT2-EU1-01

Connects single-slot charge/USB charger to a local area network via Ethernet over USB.

- 10/100/1000 Mbps speed with LEDs on module to indicate connectivity and speed.
- Mechanical switch to choose micro-USB port or RJ45 Ethernet.

Cradles

Five-slot charger

SKU# CRD-NGTC7-5SC5D

Charge-only ShareCradle kit to charge five devices.

- Can be mounted in a standard 19-inch rack system using mounting bracket [SKU# BRKT-SCRD-SMRK-01](#).
- Device with standard battery charges from 0–80% in about 1½ hours.
- Includes: Power supply [SKU# PWR-BGA12V108W0WW](#), DC cable [SKU# CBL-DC-381A1-01](#), and 5-pack of TC73 / TC78 inserts/shims.
- Sold separately: Country-specific AC line cord (listed later in this document).

Five-slot Ethernet charger

SKU# CRD-NGTC7-5SE5D

Five-slot charge/Ethernet ShareCradle kit. Charges five devices with network speeds of up to 1 Gbps.

- Device with standard battery charges from 0–80% in about 1½ hours.
- Includes: Power supply [SKU# PWR-BGA12V108W0WW](#), DC cable [SKU# CBL-DC-381A1-01](#) and 5-pack of TC73 / TC78 inserts/shims.
- Sold separately: Country-specific AC line cord (listed later in this document).

Five-slot charger

SKU# CRD-NGTC7-5SC4B

Charge-only ShareCradle kit to charge four devices and four spare Li-ion batteries.

- Can be mounted in a standard 19-inch rack system using mounting bracket [SKU# BRKT-SCRD-SMRK-01](#).
- Device with standard battery charges from 0–80% in about 1½ hours.
- Includes: Power supply [SKU# PWR-BGA12V108W0WW](#), DC cable [SKU# CBL-DC-381A1-01](#), and 4-pack of TC73 / TC78 inserts/shims.
- Sold separately: Country-specific AC line cord (listed later in this document)

Device cradle cup replacement kit

SKU# CRDCUP-NGTC7-01

One TC73 / TC78 device cradle cup replacement kit. Can be used to replace a TC5x series device cup on ShareCradle when upgrading to TC73 / TC78.

- Includes: Insert/shim.
- Also available as a 5-pack — 5 device cradle cups and 5 inserts/shims — [SKU# CRDCUP-NGTC7-05](#).
- [SHIM-CRD-NGTC7](#) Replacement inserts/shims for TC73 / TC78 ShareCradles.

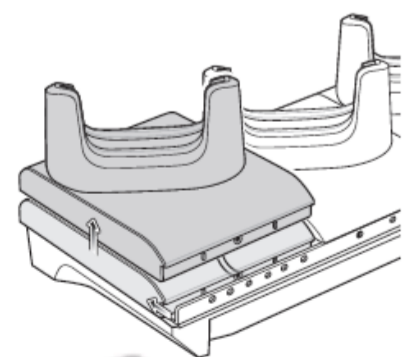

Mounting options for chargers



Rack mounting for space optimization

Optimize available space by mounting any set of five-slot chargers for TC7X on a standard, 19-inch server rack.

- Ideal for customers that have several devices per location.
- Compatible with all five-slot chargers



Mounting bracket

SKU# BRKT-SCRD-SMRK-01

Use five-slot ShareCradle mounting bracket to attach five-slot TC7X cradles to the wall or mount on a 19-inch server rack.

- Offers cable routing slots and removable tray that stores / conceals power supply.
- Adjustable orientations:
 - 25° angle for high-density (five-slot chargers).
 - Horizontal (single-slot or four-slot spare Li-ion charger).

Spare Li-ion batteries



BLE battery with PowerPrecision Plus

SKU# BTRY-NGTC5TC7-44MABLE-01

Standard capacity 4,400 mAh battery with PowerPrecision Plus and BLE beacon.

- BLE beacon allows device with this battery to be located even if powered off using [Zebra Device Tracker](#).
- Premium-grade battery cells with longer lifecycle and tested to meet rigorous controls and standards.
- Obtain advanced battery state of health information including charge level and battery age based on usage patterns.
- Sold separately: Zebra Device Tracker licenses for either 1-year SKU# SW-BLE-DT-SP-1YR or 3-years SKU# SW-BLE-DT-SP-3YR.



Standard battery with PowerPrecision Plus

SKU# BTRY-NGTC5TC7-44MA-01

- Robust housing for optimal performance and durability.
- Battery state of health features.

Spare Li-ion batteries



Extended capacity battery with PowerPrecision Plus

SKU# [BTRY-NGTC5TC7-66MA-01](#)

Extended capacity 6,600 mAh battery with PowerPrecision Plus.

- Premium-grade battery cells with longer lifecycle and tested to meet rigorous controls and standards.
- Obtain advanced battery state of health information including charge level and battery age based on usage patterns.



Wireless charging battery with PowerPrecision Plus

SKU# [BTRY-NGTC5TC7-44MAWC-01](#)

TC78 Standard capacity 4,400 mAh battery with Wireless charging and PowerPrecision Plus.

- Premium-grade battery cells with longer lifecycle and tested to meet rigorous controls and standards.
- Obtain advanced battery state of health information including charge level and battery age based on usage patterns.
- Works great with TC78 wireless charging vehicle cradle [SKU# CRD-TC78-WCVC-01](#).

Compatibility	
TC73	No
TC78	Yes

Spare battery charger



Battery charger

SKU# [SAC-NGTC5TC7-4SCHG](#)

Spare battery charger to charge any four spare Li-ion batteries.

- Standard capacity 4,400 mAh batteries charge from 0–90% in about 4 hours.
- Sold separately: Power Supply SKU# [PWR-BGA12V50W0WW](#), DC Cable [SKU# CBL-DC-388A1-01](#) and Country-specific AC Line cord (listed later in this document).



4 spare battery chargers can be mounted as shown with mounting bracket [SKU# BRKT-SCRD-SMRK-01](#)

Use to mount to wall or with standard 19" server rack for more density and save space.



4 Slot Battery Charger Conversion Kit

SKU [BTRCUP-NGTC5TC7-01](#)

Can be used to replace a TC7x series battery charger cup on five-slot ShareCradles when upgrading to TC73 / TC78.

Power supply, cables, and adaptors

Power supply and cable matrix

SKU#	Description	Note
PWR-BGA12V108W0WW	Level VI AC/DC power supply brick. AC Input: 100–240V, 2.8A. DC Output: 12V, 9A, 108W.	Included in:
CBL-DC-381A1-01	DC line cord for running multi-slot cradles from a single Level VI power supply.	<ul style="list-style-type: none"> • CRD-NGTC7-5SC5D • CRD-NGTC7-5SE5D • CRD-NGTC7-5SC4B
PWR-BGA12V50W0WW	Level VI AC/DC power supply brick. AC Input: 100-240V, 2.4A. DC Output: 12V, 4.16A, 50W.	Included in:
CBL-DC-388A1-01	DC line cord for running single-slot cradles or battery chargers from a single Level VI power supply.	<ul style="list-style-type: none"> • CRD-NGTC7-2SC1B • CRD-NGTC7-2SE1B Sold separately. Use for SAC-NGTC5TC7-4SCHG.
CBL-TC5X-USBC2A-01	USB C to USB A communications and charging cable, 1m long	Sold separately. Use to: <ul style="list-style-type: none"> • Directly charge TC73 / TC78 using a wall wart. • Connect TC73 / TC78 to a computer (developer tools). • Charge TC73 / TC78 in a vehicle (can be used with cigarette light adapter SKU# CHG-AUTO-USB1-01, if needed).
CBL-TC2Y-USBC90A-01	USB C to USB A cable with 90° bend in USB-C adapter	
25-124330-01R	Micro USB active-sync cable. Allows for active-sync connectivity between the mobile computer single- or two-slot cradle and a host device.	Sold separately. Required for use with SKU# CRD-NGTC7-2SE1B if syncing with a computer is desired while TC73 / TC78 is in the charger.
CBL-DC-523A1-01	DC Y-line cord for running two spare battery chargers to a single Level VI power supply SKU# PWR-BGA12V108W0WW .	Sold separately. Use to: Consolidate power supplies for multiple spare battery chargers proximally placed to each other.
PWR-WUA5V12W0XX	USB type A power supply adaptor (wall wart). Replace 'XX' in SKU as follows to get the right plug style based on region: US (United States) • GB (United Kingdom) • EU (European Union) AU (Australia) • CN (China) • IN (India) • KR (Korea) • BR (Brazil)	Sold separately. Use with a communications & charge cable to directly charge TC73 / TC78 device drawing power from a wall socket.

NOTE













Adaptors and cables related to vehicle charging are listed later in this document.

Accessories that power devices



Power supply, cables, and adaptors

Country-specific AC line cords: grounded, 3-prong

SKU#	Country / region	Note	
23844-00-00R	North America (United States, Canada, Mexico)	7.5 feet long Commonly used with chargers mounted in server racks	
50-16000-678R	North America (United States, Canada, Mexico)	3 feet long	
50-16000-221R	North America (United States, Canada, Mexico)	6 feet long	
50-16000-727R	Brazil	1.8 meters (6 feet) long	
50-16000-680R	Argentina	1.8 meters (6 feet) long	
50-16000-217R	American Samoa, Australia, New Guinea	1.8 meters (6 feet) long	
50-16000-218R	Japan	1.8 meters (6 feet) long	
50-16000-219R	Antigua, Bermuda, Burma, Channel Islands, Hong Kong, Iraq, Ireland, Malaysia, North Ireland, Scotland, Singapore, United Kingdom, Wales	1.8 meters (6 feet) long	
50-16000-257R	China	1.8 meters (6 feet) long	
50-16000-220R	Europe, Abu Dhabi, Bolivia, Dubai, Egypt, Iran, Korea, Russia, Vietnam	1.8 meters (6 feet) long	
50-16000-671R	Italy	1.8 meters (6 feet) long	
50-16000-669R	India, S. Africa, Africa	1.8 meters (6 feet) long	

Accessories that power devices



Power supply, cables, and adaptors

Country-specific AC line cords: ungrounded, 2-prong

SKU#	Country / region	Note
50-16000-182R	United States	Type A NEMA 1-15 plug
50-16000-255R	Europe, Abu Dhabi, Bolivia, Dubai, Egypt, Iran, Korea, Russia, Vietnam.	Type C CEE7/16 plug
50-16000-670R	Bermuda, England, Hong Kong, Iraq, Ireland, Malaysia, North Ireland, Scotland, Singapore, United Kingdom, Wales	
25-124330-01R	Cradle to USB cable Single slot cradle to PC/host USB cable. <ul style="list-style-type: none">• Used with single-slot cradle.• Micro-USB connection on cradle end	



Vehicle Cradles and Accessories



Wireless charger for use in vehicles

SKU# CRD-TC78-WCVC-01

TC78 Wireless charger for vehicles.

- Can be mounted using four AMPS-pattern holes.
- Includes a holder for stylus that can be installed either to the left or right of device in cradle or removed.
- Requires: TC78 device with wireless battery SKU# BTRY-NGTC5TC7-44MAWC-01. All sold separately.
- For power and mounting options: see [Vehicle Holders and Mounts](#) listed later in this document.

Compatibility	
TC73	No
TC78	Yes



Wired charger for use in vehicles

SKU# 3PTY-RAM-HOL-ZE17-1U

Non-locking powered vehicle charger with pogo pins.

- Ruggedized pogo pin contacts for device charging.
- 1.25m long DC barrel connector cable.
- Compatible with B and C size RAM® 2-hole diamond bases.
- Sold separately: Power Cables SKU# 3PTY-RAM-GDS-CHARGE-M55-V8BU or SKU# 3PTY-RAM-GDS-CHARGE-M55-V7B1U, and mount SKU# RAM-B-166U.
- Also available as a locking-version — SKU# 3PTY-RAM-HOL-ZE17L-1U.

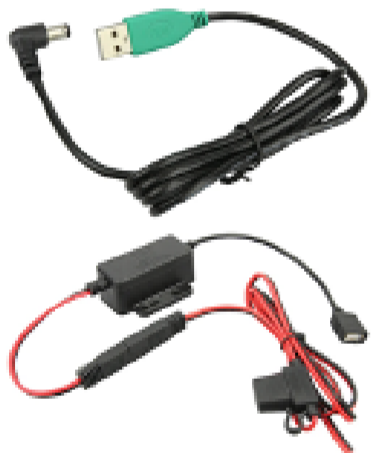

Compatibility	
TC73	Yes
TC78	Yes



Vehicle holder

SKU# CRD-TC7NG-NCCD-01

Non-powered vehicle holder.

- Holds device in vehicle installations.
- Spring tension on holder, so does not support Pistol Grip Handle.
- Compatible with B and C size RAM® 2-hole diamond bases.
- Provides access to USB-C port on bottom of device allowing device to be charged.
- Available for mounting using SKU# RAM-B-166U.

Compatibility	
TC73	Yes
TC78	Yes

NOTE

For mounting options and non-powered vehicle holders, please see section titled, "[Vehicle Holders and Mounts](#)", in this document.

For charging cables that can be used with vehicle holders, please see section titled, "[Power Supply, Cables, and Adaptors](#)", in this document.

Accessories that enable productivity solutions



Vehicle holders and mounts



Cigarette lighter adapter plug

SKU# CHG-AUTO-USB1-01

USB cigarette lighter adapter plug.

- Used with USB Type C Cable [SKU# CBL-TC5X-USBC2A-01](#) to charge device.
- Includes two USB Type A ports providing higher current (5V, 2.5A) for faster charging.



Vehicle mounting hardware

SKU# RAM-B-166U

Vehicle cradle windshield suction cup mount.

- RAM twist lock suction cup with double socket arm and diamond base adapter.
- Overall length: 6.75".
- Attaches to back of vehicle cradles.



Vehicle mounting hardware

SKU# RAM-B-238U

Vehicle cradle RAM mount ball.

- RAM 2.43" x 1.31" diamond ball base w/ 1" ball.
- Attaches to back of vehicle cradles.



Vehicle mounting hardware

SKU# 3PTY-PCLIP-241478

ProClip forklift/vehicle cradle clamp mount – for square frame mounting.

- Attaches to square bars of vehicles/forklifts.
- Clamp is 5.125" x 3.75" and can accommodate bars of varying thicknesses.
- 6" long arm on clamp uses AMPS hole pattern for mounting ProClip cradles like [SKU# 3PTY-PCLIP-241475](#).

Accessories that enable productivity solutions



Headsets

Close gaps, Open possibilities with Workforce Connect

Usher in a new era of transformation—one led by your frontline and powered by Zebra Workforce Connect. One where communication and information flows freely and gaps between teams, workflows and data are closed.

With Workforce Connect, hindered workers become effective problem solvers, contributing their best. Critical workflows are streamlined in one place, on one device, equipping workers with the information they need, right at their fingertips.

Only Zebra offers the most complete lineup of software and rugged hardware with the scalability, support and service needed to make the greatest impact where it counts—on the frontline.

[Learn more about you can elevate your frontline workers with Zebra Workforce Connect.](#)

Wired headset for Workforce Connect



SKU# HDST-USBC-PTT1-01

PTT headset with USB-C connector; one-piece solution.

- For Push-To-Talk (PTT) applications with volume up/volume down/PTT buttons. Compatible with PTT Express/PTT Pro.
- Rotating earpiece allows for right or left ear configuration. Mono headset with microphone.
- Includes clip for attaching PTT button to clothing.

Compatibility	
TC73	Yes
TC78	Yes



SKU# HDST-35MM-PTVP-02

PTT and VoIP headset with 3.5mm locking jack.

- For Push-To-Talk (PTT) and VoIP telephony. Compatible with PTT Express/PTT Pro.
- Built-in cord wrap with rotating earpiece allows for right or left ear configuration. Mono headset with microphone.
- Includes clip for attaching PTT button to clothing.
- Sold separately: Requires USB-C to 3.5mm adapter cable [SKU# ADP-USBC-35MM1-01](#)

Compatibility	
TC73	Yes
TC78	Yes



SKU# ADP-USBC-35MM1-01

USB-C to 3.5mm Adapter Cable

- Allows headsets with 3.5mm jack to be connected to TC73/TC78
- Adapter provides PTT button, volume up/down buttons.
- Adapter cable length is about 2.5ft. (78cm).
- PTT button functionality tested with [SKU# HDST-35MM-PTVP-02](#). Both the PTT button, the headset, and the adapter may be used.
- Other headsets with a PTT button not listed may not work properly and their PTT button will not be detected.
- Requires [SKU# HDST-35MM-PTVP-02](#)

Compatibility	
TC73	Yes
TC78	Yes

Headsets

Rugged Bluetooth HD voice headsets for the most demanding industrial environments

When it comes to enabling speech-driven applications and voice communications in warehouses, manufacturing plants and outdoor yards, you need a headset that is specially designed for the job. The HS3100 Bluetooth headset is loaded with features that offer everything you need in an industrial headset.

[Learn more about how these headsets deliver a superior voice experience.](#)

Wireless headsets for voice-directed picking

HS3100 rugged Bluetooth headset

Bluetooth headset for voice-directed picking applications.

- Noise cancellation tuned for Voice-Directed Picking applications.
- Swap batteries on the fly — without losing the Bluetooth connection.
- Split-second tap-to-pair simplicity using NFC. 15 hours of battery power.



SKU#	Description
HS3100-OTH	HS3100 Rugged Wired Headset Over-The-Head Headband includes HS3100 Boom Module and HSX100 OTH Headband Module
HS3100-BTN-L	HS3100 Rugged Wired Headset (Behind-the-neck headband left)
HS3100-OTH-SB	HS3100 Rugged Wired Headset (Over-the-head headband) includes HS3100 Shortened Boom Module and HSX100 OTH headband module
HS3100-BTN-SB	HS3100 Rugged Wired Headset (Behind-the-neck headband left) includes HS3100 Shortened Boom Module and HSX100 BTN headband module
HS3100-SBOOM-01	HS3100 Shortened Boom Module (includes microphone boom, battery and windscreen)

Wearable mounts and other accessories



Hand straps

SKU# [SG-NGTC5TC7-HDSTP-03](#)

Hand strap – Pack of 3.

- Allows device to be easily held in palm of hand.
- Attaches directly to device
- Includes loop for holding optional stylus.



Stylus

SKU# [SG-STYLUS-TCX-MTL-03](#)

Fiber tipped stylus – pack of 3.

- Heavy-duty and made from stainless steel / brass. No plastic parts — real pen feel. Can be used in rain.
- Micro-knit, hybrid-mesh, fiber tip provides silent, smooth gliding use. 5" length.
- Big improvement over rubber tipped or plastic tipped stylus.
- Compatible with all capacitive touch screen devices.
- Tether to device or hand strap using [SKU# SG-TC5NGTC7NG-TETHR-03](#).



Stylus tether

SKU# [SG-TC5NGTC7NG-TETHR-03](#)

Stylus tether.

- Can be attached to device tower bar.
- When hand strap is used, tether should attach to hand strap [SKU# SG-NGTC5TC7-HDSTP-03](#) directly (not to terminal towel bar).
- String type tether prevents loss of stylus.
- NOTE: Other Zebra coiled tethers are not recommended for use with TC73/TC78 as they may interfere with other accessories.

Accessories that enable productivity solutions



Trigger handles and accessories



Electronic trigger handle

SKU# TRG-NGTC7-ELEC-01

Pistol-grip trigger handle.

- Uses electrical trigger via contacts on back side of TC73/TC78.
- Trigger handle accessory offers customers the option of using the product in a gun form factor, ideal for scan-intensive situations.
- Does not block access to rear facing camera and flash allowing camera to be used while using the trigger handle.
- Compatible with both standard and extended capacity batteries.
- Sold separately: Optional wrist strap [SKU# SG-PD40-WLD1-01](#).

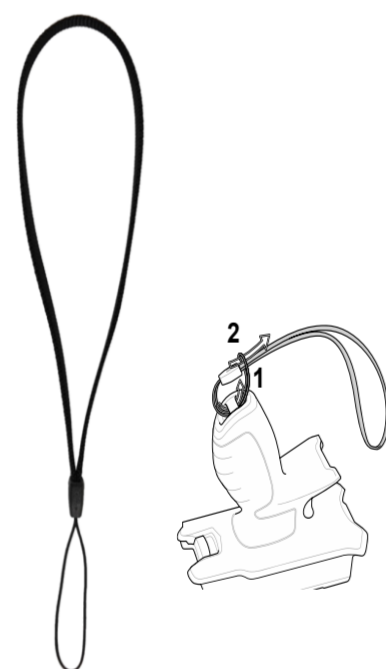

Trigger handle wrist strap

SKU# SG-PD40-WLD1-01

Looping wrist strap for trigger handle.

- Attaches to bottom of pistol-grip trigger handle.

Accessories that enable productivity solutions



Soft holsters, and screen protectors



Soft holster

SKU# [SG-NGTC5TC7-HLSTR-01](#)

Soft holster.

- Vertical orientation with open bucket design to accommodate TC73 / TC78 pistol-grip trigger handle, and/or hand strap.
- Strap on rear of holster allows adjustment for use with the accessory options mentioned above.
- Includes loop for storage of optional stylus. Nonrotating for maximum durability.
- Holster is leather material and includes cut-out for speaker output.
- Also compatible with trigger handle [SKU# TRG-NGTC7-ELEC-01](#).



Screen protectors

SKU# [SG-NGTC7-SCRNP-03](#)

Screen protector – pack of 3.

- Tempered glass.
- Includes alcohol wipes, cleaning cloth, and instructions needed for screen protector installation.